

**Industrial Single-Port 802.3bt PoE++ Splitter**

**IPOE-17xS Series**

**User's Manual**

# Table of Contents





1. Package Contents.....	3
2. Product Specifications .....	4
3. Hardware Introduction .....	7
3.1 Front Panel and LED Indicators .....	7
3.2 4-pin Power Output Terminal Block.....	8
3.3 DC Voltage DIP Switch .....	9
3.4 Grounding the Device.....	10
4. Installation .....	11
5. Three-View Diagram .....	13
Customer Support.....	15

# 1. Package Contents

Thank you for purchasing PLANET Industrial 802.3bt PoE++ Splitter, IPOE-17xS Series. **"PoE Splitter"** mentioned in this manual refers to the IPOE-17xS Series. The description of this series is shown below:

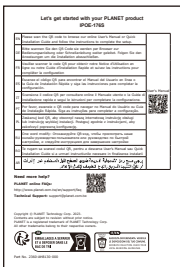
IPOE-173S	Industrial Single-Port 10/100/1000Mbps 802.3bt PoE++ Splitter
IPOE-176S	Industrial Single-Port 10Gbps 802.3bt PoE++ Splitter

Open the box of the Industrial 802.3bt PoE++ Splitter and carefully unpack it. The box should contain the following items:

Industrial PoE++ Splitter x 1	Quick Start QR Code Sheet x 1	
		
DIN-rail Kit x 1	RJ45 Dust Caps x 2	Wall-mount Kit x 1
		

If any of these are missing or damaged, please contact your dealer immediately.

## 2. Product Specifications

Product		IPOE-173S	IPOE-176S
HW Version		2.0	1.0
Hardware Specifications			
Interface	PoE Input Port	1 10/100/1000BASE-T RJ45	1 10M/100M/1G/2.5G/5G/10G BASE-T RJ45
	Data Output Port	1 10/100/1000BASE-T RJ45	1 10M/100M/1G/2.5G/5G/10G BASE-T RJ45
	DC Out Plug Connector	1 removable 4-pin terminal block	
	DIP Switch	12V/19V/24V DC output	
LED Indicators		PoE Input: 30W (Green) 60W (Green) 90W (Green) DC Voltage: 12V (Green) 19V (Green) 24V (Green)	
Data Rate		10/100/1000Mbps	10M/100M/1G/2.5G/5G/10Gbps
Dimensions (W x D x H)		32 x 87 x 135 mm	
Weight		440g	433g
Installation		DIN-rail/wall mountable	
ESD Protection		4KV	
EFT Protection		4KV	
Enclosure		IP30 metal case	
Power Requirements		4-pair 802.3at PoE+ and 802.3bt PoE++ PoE DC 48 ~ 54V	

Power Consumption	System on with PoE input	5.3 watts	5.5 watts
	Full loading with maximum 12V DC, 6.8A output	75.83 watts	75.45 watts
Power Output	802.3 bt type 4 PoE++ input	12V DC, 6.8A (max.) 19V DC, 4.3A (max.) 24V DC, 3.3A (max.)	
Network Cable	802.3 bt PoE++ input (60W+)	4-pair UTP Cat. 5e, 6, up to 100m (328ft)	Twisted-pair cable up to 100 meters (328ft) <b>10BASE-T:</b> 4-pair UTP Cat. 3, 4, 5, 5e, 6, 6A 100BASE-TX: 4-pair UTP Cat. 5, 5e, 6, 6A <b>1G/2.5G:</b> 4-pair UTP Cat 5e/Cat 6/Cat 6A/ Cat 7 <b>5G:</b> 4-pair UTP Cat 6/Cat 6A/Cat 7 <b>10G:</b> 4-pair UTP Cat 6A/Cat 7
	802.3at PoE+ input (30W)	2-pair UTP Cat. 5, 5e, 6, up to 100m (328ft)	
Power over Ethernet			
PoE Standard	802.3 bt PoE++ 4-pair 802.3at PoE+		
Power Output	DC 12V/19V/24V by DIP switch control		
PoE Power Supply Type	End-span + Mid-span End-span Mid-span		
Power Pin Assignment	1/2 (+), 3/6 (-); 4/5 (+), 7/8 (-) or 1/2 (-), 3/6 (+); 4/5 (+), 7/8 (-)		

Remote Power Distance	NA	1G/2.5G speed: 100M (max.) 5G/10G speed: 80M (max.) (cat6A/cat7)
Standards Conformance		
Standards Compliance	IEEE 802.3 10BASE-T Ethernet IEEE 802.3u 100BASE-TX Fast Ethernet IEEE 802.3ab 1000BASE-T Gigabit Ethernet IEEE 802.3at Power over Ethernet Plus IEEE 802.3bt 4-pair Power over Ethernet Type 4	IEEE 802.3 10BASE-T Ethernet IEEE 802.3u 100BASE-TX Fast Ethernet IEEE 802.3ab 1000BASE-T Gigabit Ethernet IEEE 802.3bz 2.5G/5G/10GBASE-T IEEE 802.3af Power over Ethernet IEEE 802.3at Power over Ethernet Plus IEEE 802.3bt 4-pair Power over Ethernet Type 4
Regulatory Compliance	FCC Part 15 Class A, CE	
Environment		
Operating Temperature	-40 ~ 75 degrees C	
Storage Temperature	-40 ~ 85 degrees C	
Humidity	5 ~ 95% (non-condensing)	

### 3. Hardware Introduction

#### 3.1 Front Panel and LED Indicators

IPOE-173S    IPOE-176S    ■ PoE input indicators

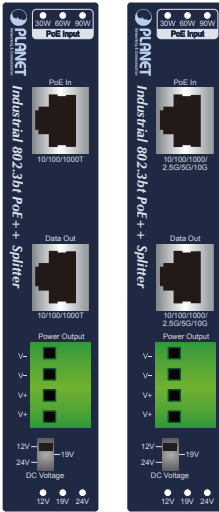

**Figure 3-1:** Front Panel of IPOE-17xS Series

LED	Color	Function
30W	Green	Lights to indicate the PoE Splitter is working in 802.3at PoE mode.
60W	Green	Lights to indicate the PoE Splitter is working in 802.3bt type 3 PoE mode.
90W	Green	Lights to indicate the PoE Splitter is working in 802.3bt type 4 PoE mode.

■ DC output voltage indicators

LED	Color	Function
12V	Green	Lights to indicate the PoE Splitter's output is in 12V DC mode.
19V	Green	Lights to indicate the PoE Splitter's output is in 19V DC mode.
24V	Green	Lights to indicate the PoE Splitter's output is in 24V DC mode.

## 3.2 4-pin Power Output Terminal Block

If there is no power socket in your network environment, PLANET IPOE-17xS Series provides DC power for this Ethernet device conveniently. The IPOE-17xS Series splits the transmission of the power and data.

From top to down, there are Negative (V-), Negative (V-), Positive (V+) and Positive (V+), and two sets of DC power output contact.

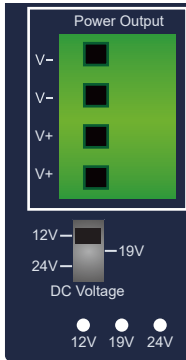

**Figure 3-2:** Terminal Block of IPOE-17xS Series \*IPOE-176S\_PS.png



### Note

It comes with three DC outputs -- 12V, 6.8A, 19V, 4.3A or 24V, 3.3A, **totaling 70 watts of DC output power**, which means that DC1 + DC2 cannot be over the 70-watt DC output power limit. Otherwise, it might cause the power output to malfunction or damage.



### 3.3 DC Voltage DIP Switch

It provides three kinds of DC power output through its DIP switch and its voltage and current are shown below:

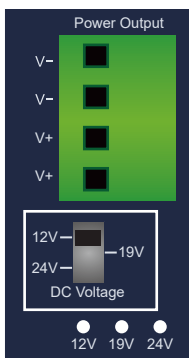

Figure 3-3: DIP Switch of IPOE-17xS Series



Caution

1. Please check the power requirements of the device carefully that is going to get the power from the IPOE-17xS Series.
2. If the power requirement is higher than the IPOE-17xS Series that can supply, current overload might shut down the IPOE-17xS Series itself. Thus, it will also shut down your device as well.
3. Please ensure the output voltage is correct for remote device. Otherwise, it will damage your remote device.



Caution

Do not switch on/off the Power DIP during operation. Otherwise, it will damage your IPOE-17xS Series and remote device. If you want to switch from one output voltage to another via DIP switch, plug out the **"PoE In"** cable and wait for 3 seconds until the PoE Input LEDs are completely OFF.

### 3.4 Grounding the Device

Users **MUST** complete grounding wired with the device; otherwise, a sudden lightning could cause fatal damage to the device.

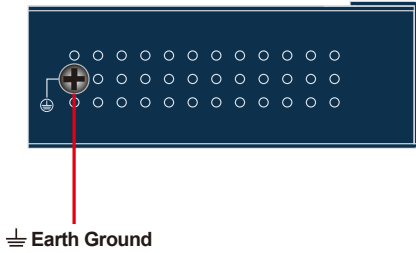

Note

EMD (Lightning) DAMAGE IS NOT COVERED UNDER WARRANTY.

## 4. Installation

### Wiring the Power Outputs

Please follow the steps below to insert the power wires.

**Step 1:** Please find one terminal block connector within two DC power outputs shown below:

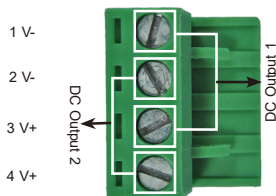

#### Note

The wire gauge for the terminal block should be in the range of 12 ~ 24 AWG.

**Step 2:** Insert the Negative/Positive DC wires into the V- / V+ terminal; Terminals 1 and 3 for Power 1; Terminals 2 and 4 for Power 2.

**Step 3:** Connect the other end of DC power wires to the power devices. Tighten the wire-clamp screws for preventing the wires from loosening.

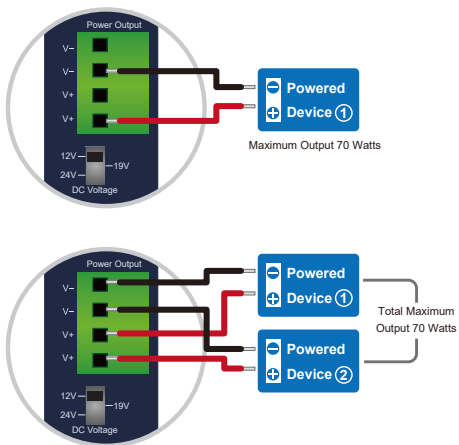

**Step 4:** Install the terminal block on PLANET IPOE-17xS Series Splitter.

**Step 5:** Connect the network copper cable (RJ45) from an 802.3bt PoE++ PSE to the IPOE-17xS Series Splitter where the power and data are separately transmitted to a PD as shown in the figure below (The following figure is based on the IPOE-173S. The display of the other IPOE-17xS Series is the same):

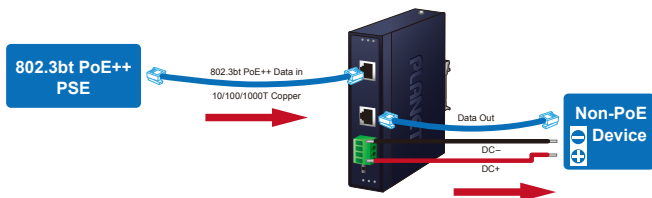

Caution

Make sure the IPOE-17xS Series' output voltage (DC 12V/19V/24V) is correct before applying power to a remote device.

# 5. Three-View Diagram

## IPOE-173S

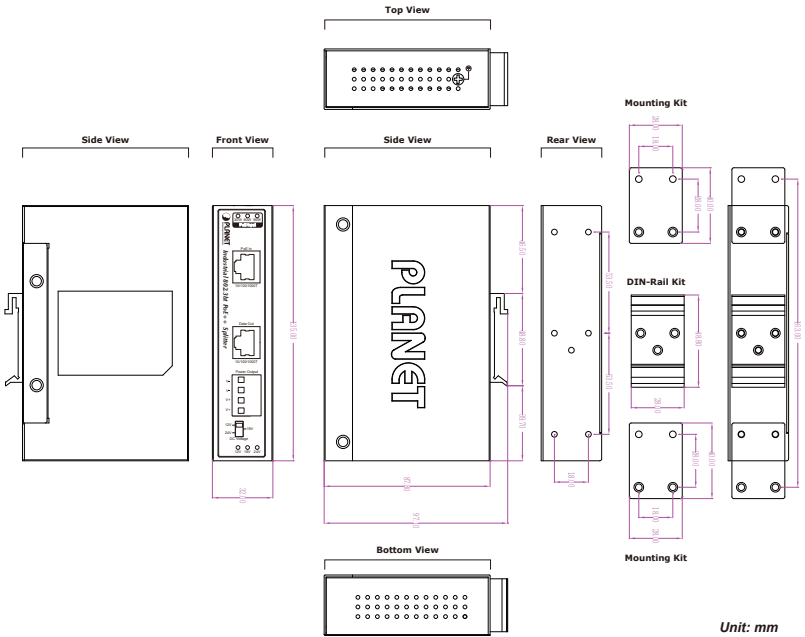
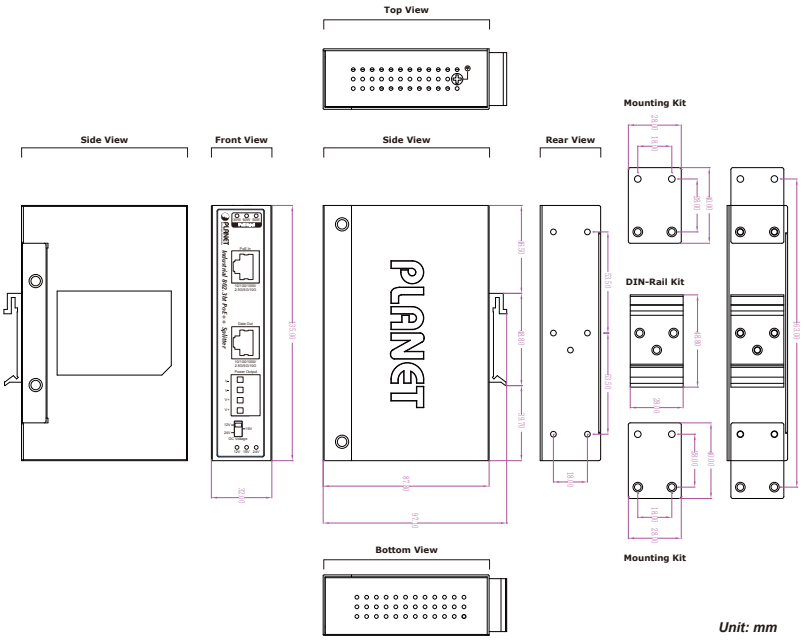

Figure 5-1: IPOE-173S Three-View Diagram

# IPOE-176S



Unit: mm

Figure 5-2: IPOE-176S Three-View Diagram

---

## ***Customer Support***

Thank you for purchasing PLANET products. You can browse our online FAQ resource on PLANET web site first to check if it could solve your issue. If you need more support information, please contact PLANET support team.

PLANET online FAQs:

<http://www.planet.com.tw/en/support/faq>

Support team mail address:

[support@planet.com.tw](mailto:support@planet.com.tw)

Copyright © PLANET Technology Corp. 2023.

Contents are subject to revision without prior notice.

PLANET is a registered trademark of PLANET Technology Corp.

All other trademarks belong to their respective owners.

---

## FCC Warning

This device has been tested and found to comply with the limits for a Class A digital device, pursuant to Part 15 of the FCC Rules. These limits are designed to provide reasonable protection against harmful interference when the equipment is operated in a commercial environment. This equipment generates, uses, and can radiate radio frequency energy and, if not installed and used in accordance with the Instruction manual, may cause harmful interference to radio communications. Operation of this equipment in a residential area is likely to cause harmful interference in which case the user will be required to correct the interference at his own expense.

## CE Mark Warning

This device is compliant with Class A of CISPR 32. In a residential environment this equipment may cause radio interference.

## WEEE Warning



To avoid the potential effects on the environment and human health as a result of the presence of hazardous substances in electrical and electronic equipment, end users of electrical and electronic equipment should understand the meaning of the crossed-out wheeled bin symbol. Do not dispose of WEEE as unsorted municipal waste and have to collect such WEEE separately.